

Access Gold™ *Security made easy.*

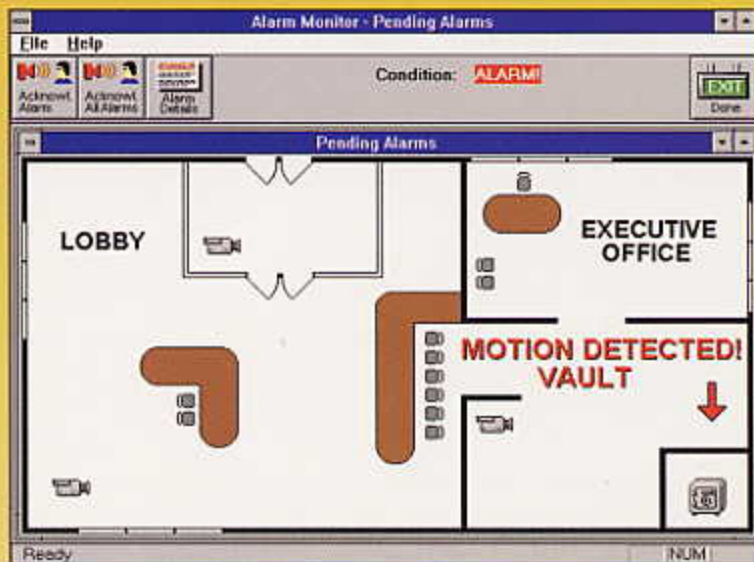

Powerful, multi-user. Windows-based, flexible, colorful, screen graphics

...all with a click of your mouse!

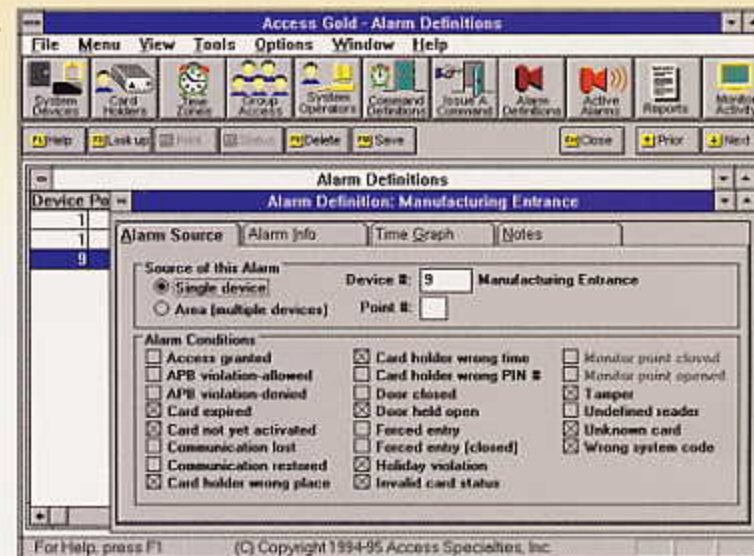
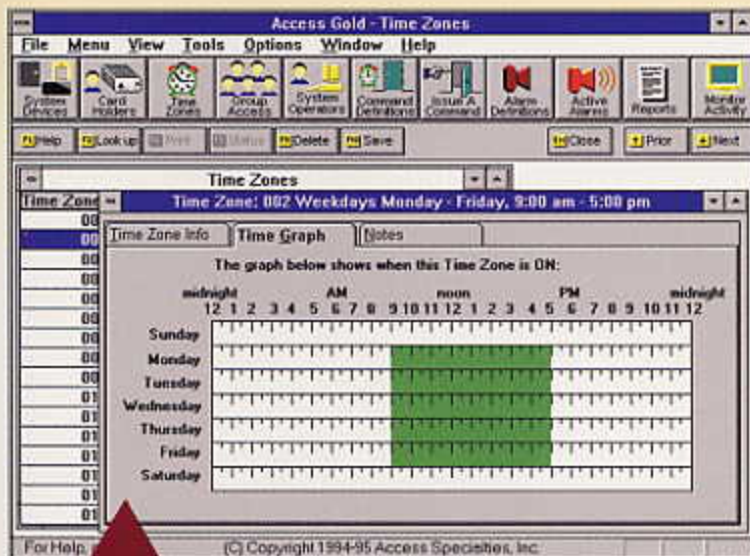

ACCESS SPECIALTIES, INC. CALL 1-800-332-1013 FOR A FREE DEMO DISK

Access Gold™ Sec

▲ Easy to use

Familiar screens, one-step toolbar buttons, carefully designed screen layouts, and complete on-line help system all make Access Gold™ exceptionally easy to learn and use. The program instinctively guides you through all the essential elements of access control with just a click of your mouse.



Colorful time graphs and other visual tools greatly increase system understanding, and decrease user-interface errors.

▲ Multi-user and multi-tasking

Access Gold™ operates off-line, on-line and with other Windows programs, eliminating the need for a dedicated computer. For increased productivity, multiple operators may use the program simultaneously. Because Access Gold™ operates on standard Local Area Networks, any computer on the network, with the appropriate system operator privileges, can access the program.

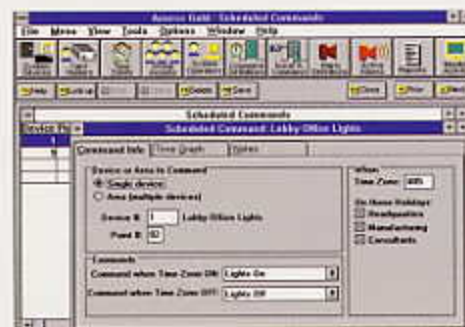

Access Gold™'s flexible features and powerful capabilities are unsurpassed.

▲ Technology you already use

As a Windows-based application operating on standard hardware, Access Gold™ ensures smooth integration with other off-the-shelf products greatly reducing expenditures to a minimum.

▲ Colorful, graphic interface

Bright, vivid graphs give instant meaning to time zones, access groups and other integrated concepts so that "What You See Is What You Get." Areas and databases that an operator may interact with are displayed in full color, while restricted areas are clearly disabled. Visual clues like these increase system understanding, and enhance user interaction. This saves time and money, allowing you to more effectively manage your facility.

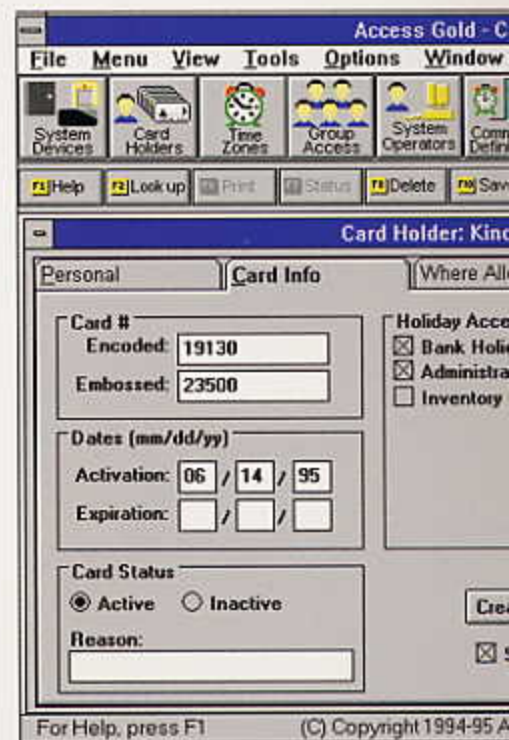

▲ Flexible features and capabilities

Issue commands to a single device or an entire area, assign card holders to up to 12 different access groups, define multiple holiday lists and anti-pass-back zones, restrict operator access privileges by database, and much more! With so much built-in flexibility, you can customize your system to meet your specific needs. Access Gold™ accommodates virtually any environment, from multi-tenant property owners with over 1,000 readers, to businesses with satellite offices across the country, to single-user applications with only a few readers.

Security made easy.

g on a standard Local Area Network,
n with other security products such
is open architecture and integration
duce costs, and keep upgrade

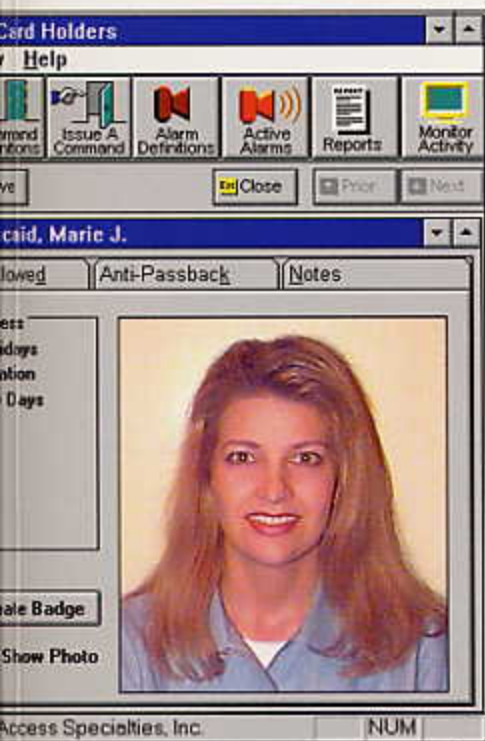

As a Windows-based access control system, Access Gold™ offers you the flexibility to fully integrate with other security products such as Photo Imaging and CCTV.

▲ Powerful alarm routing and graphic display

Multi-priority alarm monitoring, routing and messaging, as well as alarm graphics make Access Gold™ one of the most comprehensive systems around. Route specific types of alarms to the appropriate person. Receive immediate notification of an alarm through your pager. It tells you exactly where and what type of alarm to prepare for.



Powerful alarm graphics instantly identify where an alarm is occurring.



Over 20 different types of conditions are available for defining virtually any type of alarm.

▲ Flexible reporting capabilities

Create customized reports that track card holders, specific transactions, door activity and more. For effective time management, maintain a report library of frequently generated reports, and then schedule them to print out automatically.

▲ Supports leading card technologies

Proximity, Wiegand, Barium Ferrite, Magnetic Stripe, Bar Code and Keypad are all supported by Access Gold™. This gives you total flexibility to combine several technologies within one system.



ACCESS SPECIALTIES, INC.

Access Gold™ Security made easy.

Distribute intelligent access control panels throughout your facility, regionally, or nationally!

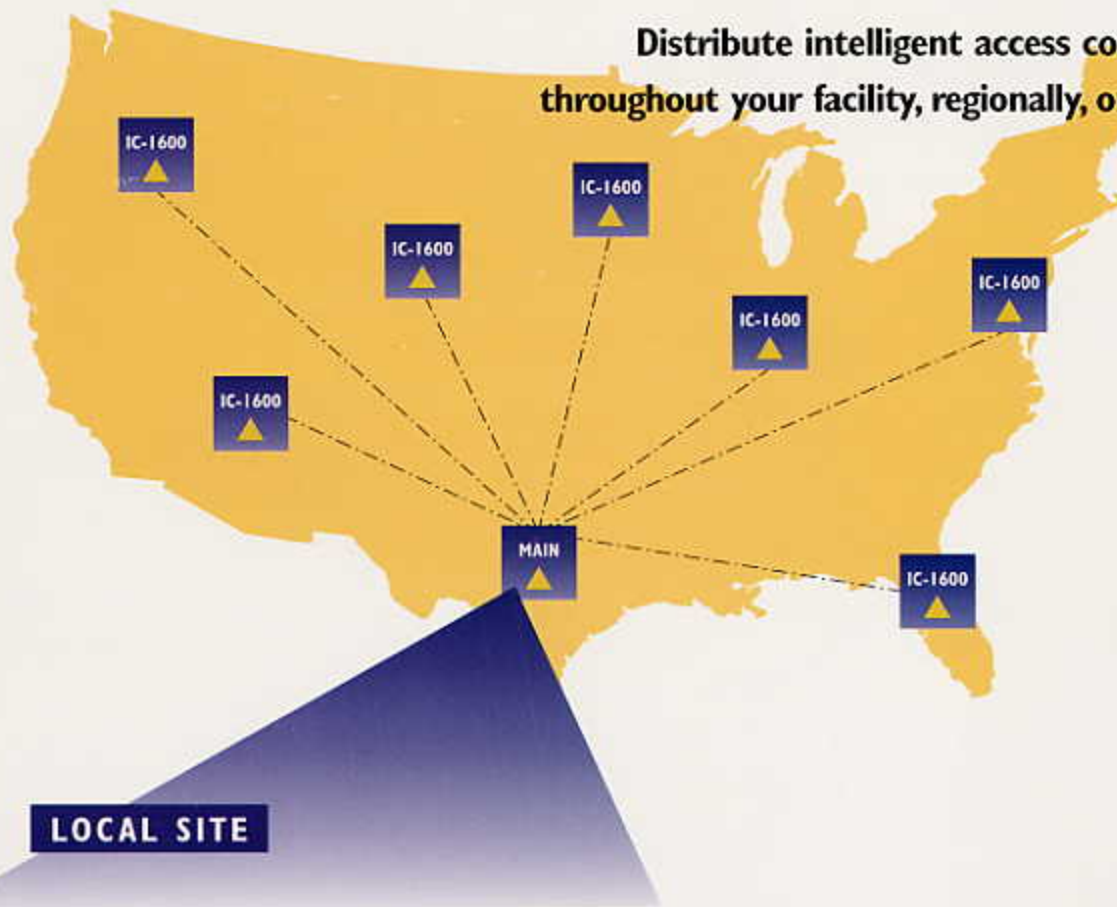

LOCAL SITE

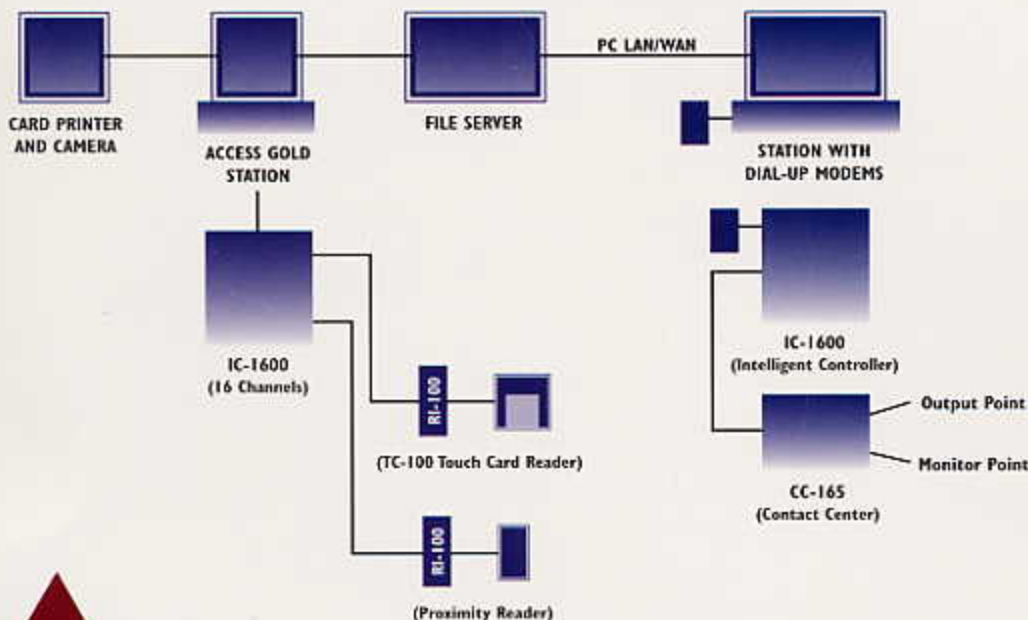

SPECIFICATIONS

Access Gold™ Software Application
Single or Multi-user versions available
Operates on Microsoft Networks:
Windows 95 Peer-to-Peer and Windows NT

SYSTEM REQUIREMENTS

Pentium 200 MHz recommended
(major name brand)
Pentium 166 MHz (minimum)
64 MB RAM recommended
(32 MB minimum)
512K CPU cache
4.0 GB Hard disk (1.2 GB minimum)
PCI Hard disk controller (major name brand)
64 bit PCI VGA Adapter
Serial Ports (as needed) utilizing
16550 UART's or newer
Requires Windows 95 or NT

 ACCESS SPECIALTIES, INC.

1-800-332-1013

Windows is a trademark of
Microsoft Corporation